

Pompa peristaltica per lavastoviglie

Regolazione elettronica tempo-pausa

Peristaltic pump for dish-washing machines / Electronic regulation time-pause

Pompe péristaltique pour lave-vaisselle / Réglage électronique temps-pause



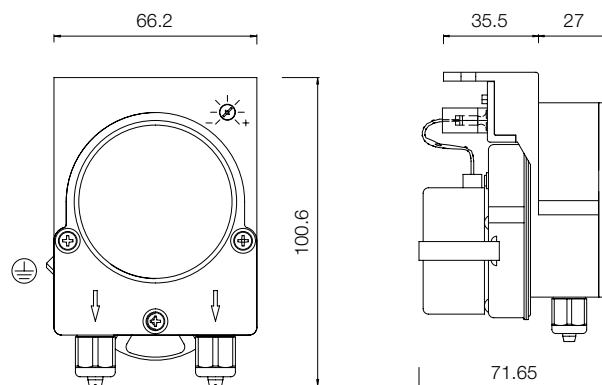
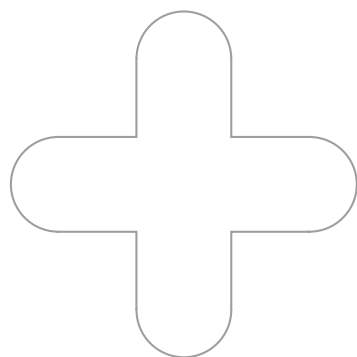

Bomba peristáltica para lavajillas / Regulación electrónica tiempo-pausa



230V 50/60Hz

Dimensioni - Dimensions - Dimensions - Dimensiones



 Per brillante Portata max. l/h 0,7 Tubo silicone	 For rinse additive Max. delivery l/h 0,7 Silicone tube
 Pour agent de brillantage Débit max. l/h 0,7 Tube de silicone	 Para abrillantador Capacidad máx. l/h 0,7 Tubo de silicona

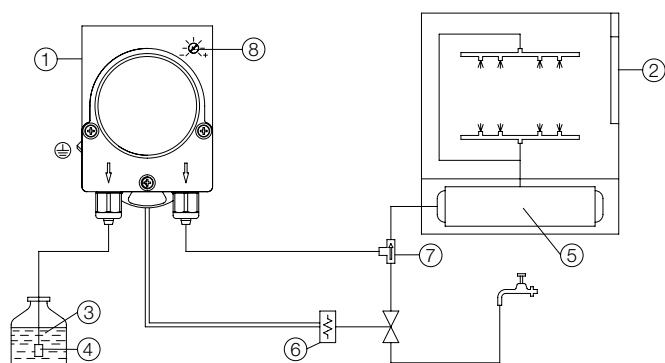

- ① Pompa peristaltica
Peristaltic pump
Pompe péristaltique
Bomba peristáltica
- ② Lavastoviglie
Dish washer/Lave-vaisselle
Lavavajillas
- ③ Brillantante
Rinse additive/Agent de brillantage
Abrillantador

- ④ Filtro
Filter/Filtre
Filtro
- ⑤ Boiler
Boiler/Chaudière
Calentador eléctrico
- ⑥ Elettrovalvola
Solenoid valve/Soupape électrique
Electroválvula

- ⑦ Raccordo valvola N.R.
Nonreturn valve union
Raccord soupape de N.R.
Rückschlagventilsanschlussstück
Racor válvula de retención
- ⑧ Regolazione tempo-pausa
Regulation time-pause
Réglage temps-pause
Regelung Zeit-Pause
Regulación tiempo-pausa